

## FITTING INSTRUCTION

| Clamp mark in acc. with |     | Cables joining            |
|-------------------------|-----|---------------------------|
| ISO                     | PN  |                           |
| 1                       | L   | Left directional lights   |
| 2                       | +   | Rear fog lights           |
| 3                       | 31  | Ground                    |
| 4                       | R   | Right directional lights  |
| 5                       | 58R | Right side parking lights |
| 6                       | 54  | Stoplights                |
| 7                       | 58L | Left side parking lights  |

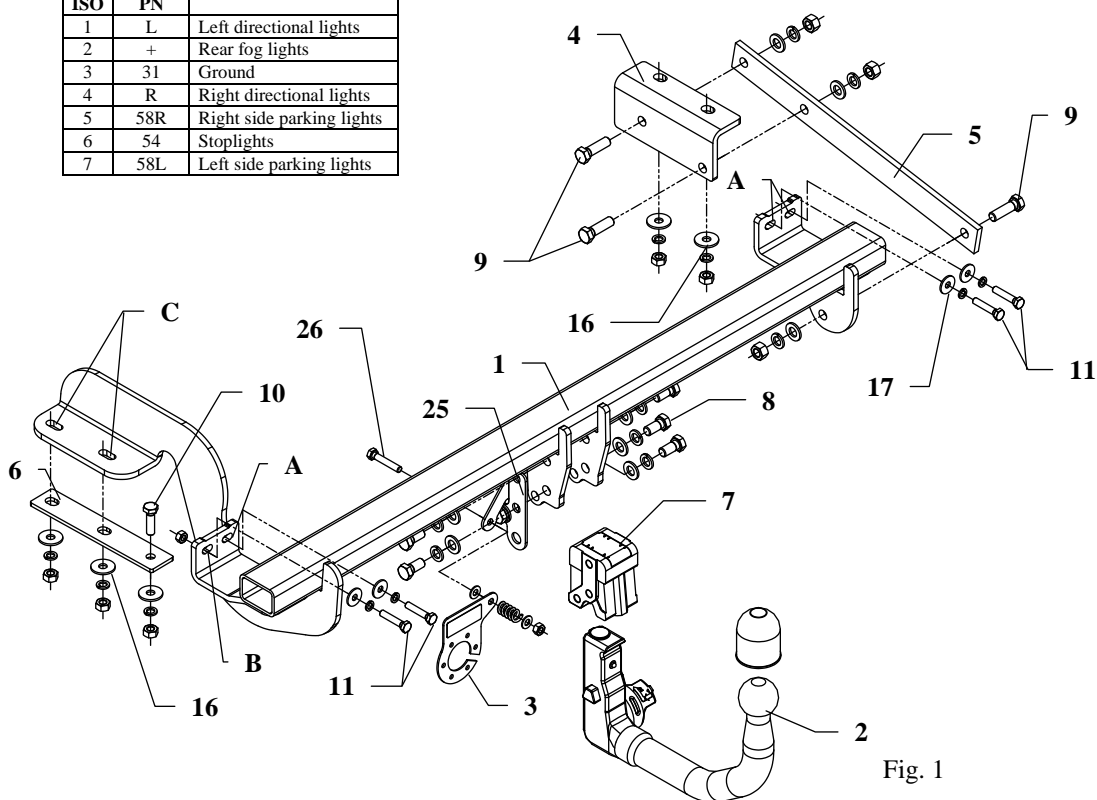

Fig. 1

This towing hitch is designed to assembly in following cars:  
**PEUGEOT 3008 I, except Hybrid**, produced since 06.2009 till 04.2016,  
 catalogue no. **F35V** and is prepared to tow trailers max total weight **1650 kg** and max vertical mass **70 kg**.

### From manufacturer

Thank you for buying our product. Their reliability has been confirmed in many tests. Reliability of towing hitch depends also on correct assembly and right operation. For this reasons we kindly ask to read carefully this instruction and apply to hints.

*The towing hitch should be install in points described by a car producer.*

## The instruction of the assembly

1. From the bottom of the car one ought to unscrew three bolts fastening bumper.
2. In points A (see fig. 1) one ought to unscrew the original bolts.
3. Unscrew fastenings of rear muffler.
4. Bend the heat shield inwards by 10mm (if necessary).
5. Apply the main bar of the towing hitch (pos. 1) at points A, B and C.
6. Assembly elements of muffler fastenings with fish-plate (pos. 6).
7. Apply the angle bar (pos. 4) to the right chassis member.
8. Fix loosely flat bar (pos. 5) to the angle bar (pos. 4) and to the main bar of the towing hitch (pos. 1) using bolts M12x40mm (pos. 9).
9. Fix body of the automat (pos. 7) using bolts M12x25mm (pos. 8) from accessories. Place tow-ball (pos. 2) according to supplied instruction.
10. Fix socket plate (pos. 3) as shown on the drawing.
11. Tighten all bolts according to the torque shown in the table.
12. Fix bolts fastening bumper again.
13. Connect electric wires of 7-poles socket according to the instruction of the car. (Recommend to make at authorized service station).
14. Complete paint layer damaged during installation.

### Torque settings for nuts and bolts (8,8):

|                     |                      |                     |
|---------------------|----------------------|---------------------|
| <b>M6</b> - 11 Nm   | <b>M 8</b> - 25 Nm   | <b>M 10</b> - 50 Nm |
| <b>M 12</b> - 87 Nm | <b>M 14</b> - 138 Nm | <b>M16</b> - 210 Nm |











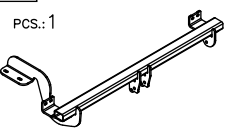
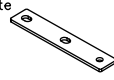













### NOTE

After install the towing hitch you should get adequate note in registration book (at authorised service station). The car should be equipped with:

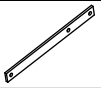
- Indicators
- Tow mirrors

After 1000km check all bolts and nuts. The ball of towing hitch must be always kept clear and conserve with a grease.

## Towing hitch accessories:

|  |  |   |   |
|--|--|---|---|
| Pos. 1<br>Main bar<br>PCS.: 1<br>     | Pos. 6<br>Fish-plate<br>PCS.: 1<br>           | Pos. 13<br>Nut 8 B M10<br>PCS.: 5<br>            | Pos. 20<br>Spring washer ø8.2mm<br>PCS.: 4<br> |
|  | Pos. 7<br>Body of the automat<br>PCS.: 1<br>  | Pos. 14<br>Nut 8 B M8<br>PCS.: 2<br>             | Pos. 21<br>Ball cover<br>PCS.: 1<br>           |
| Pos. 2<br>Tow ball<br>PCS.: 1<br>     | Pos. 8<br>Bolt 8,8 B M12x25mm<br>PCS.: 6<br>  | Pos. 15<br>Plain washer ø13mm<br>PCS.: 9<br>     | Pos. 24<br>Body plug<br>PCS.: 1<br>            |
| Pos. 3<br>Socket plate<br>PCS.: 1<br> | Pos. 9<br>Bolt 8,8 B M12x40mm<br>PCS.: 3<br>  | Pos. 16<br>Washer ø30xø10.5x2.5mm<br>PCS.: 5<br> | Pos. 25<br>Handle<br>PCS.: 1<br>               |
| Pos. 4<br>Angle bar<br>PCS.: 1<br>    | Pos. 10<br>Bolt 8,8 B M10x35mm<br>PCS.: 1<br> | Pos. 17<br>Washer ø24xø8.4x2mm<br>PCS.: 4<br>    | Pos. 26<br>Bolt 8,8 B M8x45mm<br>PCS.: 1<br>   |
| Pos. 5<br>Flat bar<br>PCS.: 1<br>     | Pos. 11<br>Bolt 8,8 B M8x40mm<br>PCS.: 4<br>  | Pos. 18<br>Spring washer ø12.2mm<br>PCS.: 9<br>  | Pos. 27<br>Plain washer ø8mm<br>PCS.: 2<br>    |
|  | Pos. 12<br>Nut 8 B M12<br>PCS.: 3<br>         | Pos. 19<br>Spring washer ø10.2mm<br>PCS.: 5<br>  | Pos. 28<br>Spring<br>PCS.: 1<br>               |



**PPUH AUTO-HAK Sp.J.**

Produkcja Zaczepów Kulowych  
Henryk i Zbigniew Nejman  
76-200 SŁUPSK ul. Słoneczna 16K  
tel/fax (059) 8-414-414; 8-414-413  
E-mail: [office@autohak.com.pl](mailto:office@autohak.com.pl)  
[www.autohak.com.pl](http://www.autohak.com.pl)

## Towing hitch (without electrical set)

Class: **A50-X** Cat. no. **F35V**

Designed for:

Manufacturer: **PEUGEOT**

Model: **3008 I, except Hybrid**

produced since 06.2009 till 04.2016

Technical data:

**D-value: 9,2 kN**

maximum trailer weight: **1650 kg**

maximum vertical cup mass: **70 kg**

**Approval number according to Directive 94/20/EC: e20\*94/20\*1114\*00**

## Foreword

This towing hitch is designed according to rules of safety traffic regulations. The towing hitch is a safety component and can be install only by qualified personnel. Any alteration or conversion of the towing hitch is prohibited and would lead to cancellation of design certification. Remove insulating compound and underseal from vehicle (if present) in the area of the matting surfaces of the towing hitch. The vehicle manufacturer's specifications regarding trailer mass and max. vertical cup mass are decisive for driving whereat values for the towing hitch cannot be exceeded.

*D-value formula:*

$$\frac{\text{Max trailer weight [kg]} \times \text{Max vehicle weight [kg]}}{\text{Max trailer weight [kg]} + \text{Max vehicle weight [kg]}} \times \frac{9,81}{1000} = D \text{ [kN]}$$