

**MERCEDES GLC
(X253) + AMG-Pakiet**

Cat. no:

D52



09.2015 →



E20-55R-01 4849



2h

D

13,2 kN



R=2730 kg

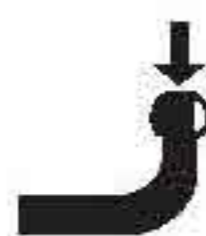

S=100 kg

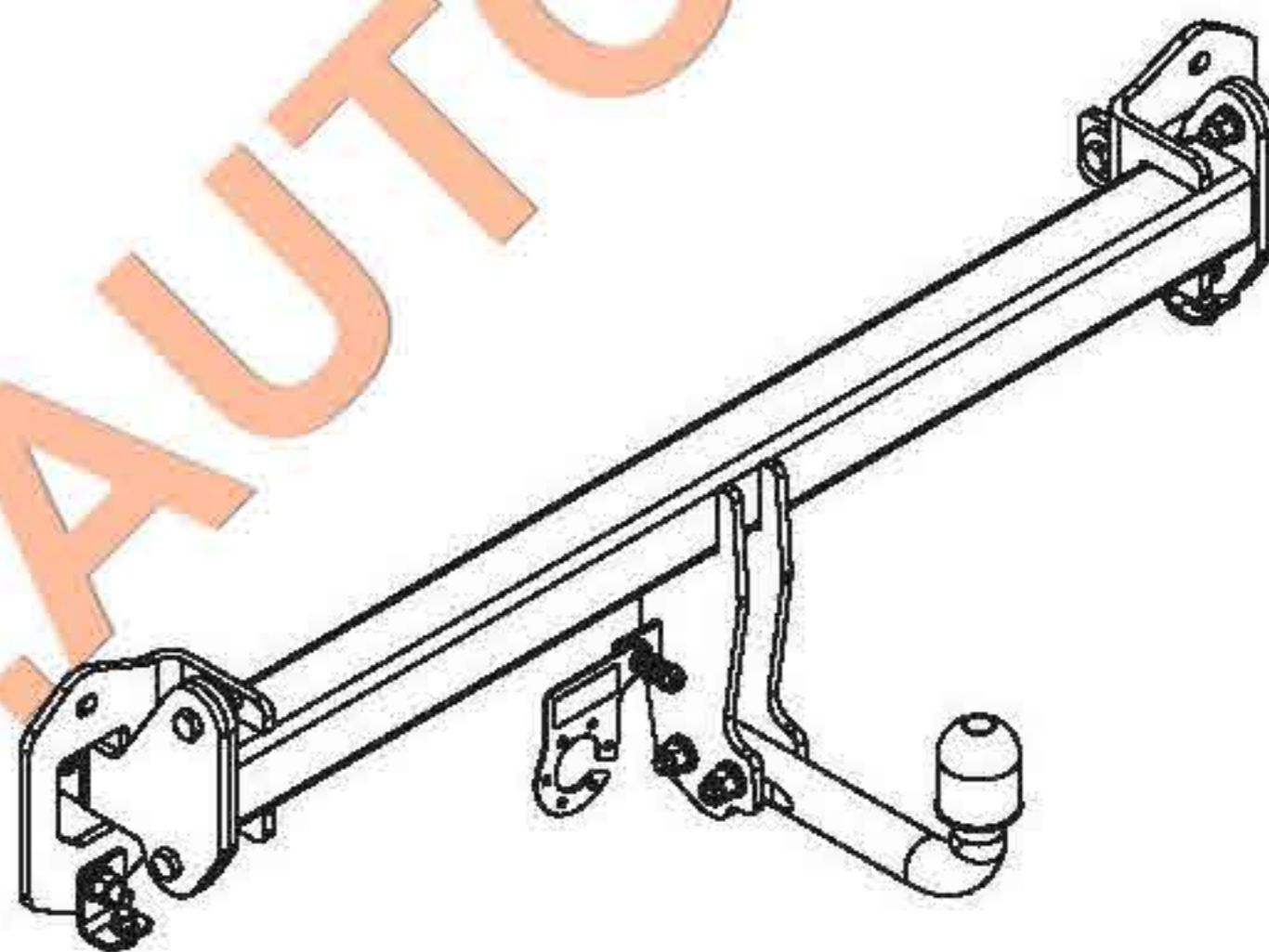

M6 - 8,5 Nm
M10 - 41 Nm
M14 - 112 Nm

M8 - 20 Nm
M12 - 70 Nm
M16 - 170 Nm









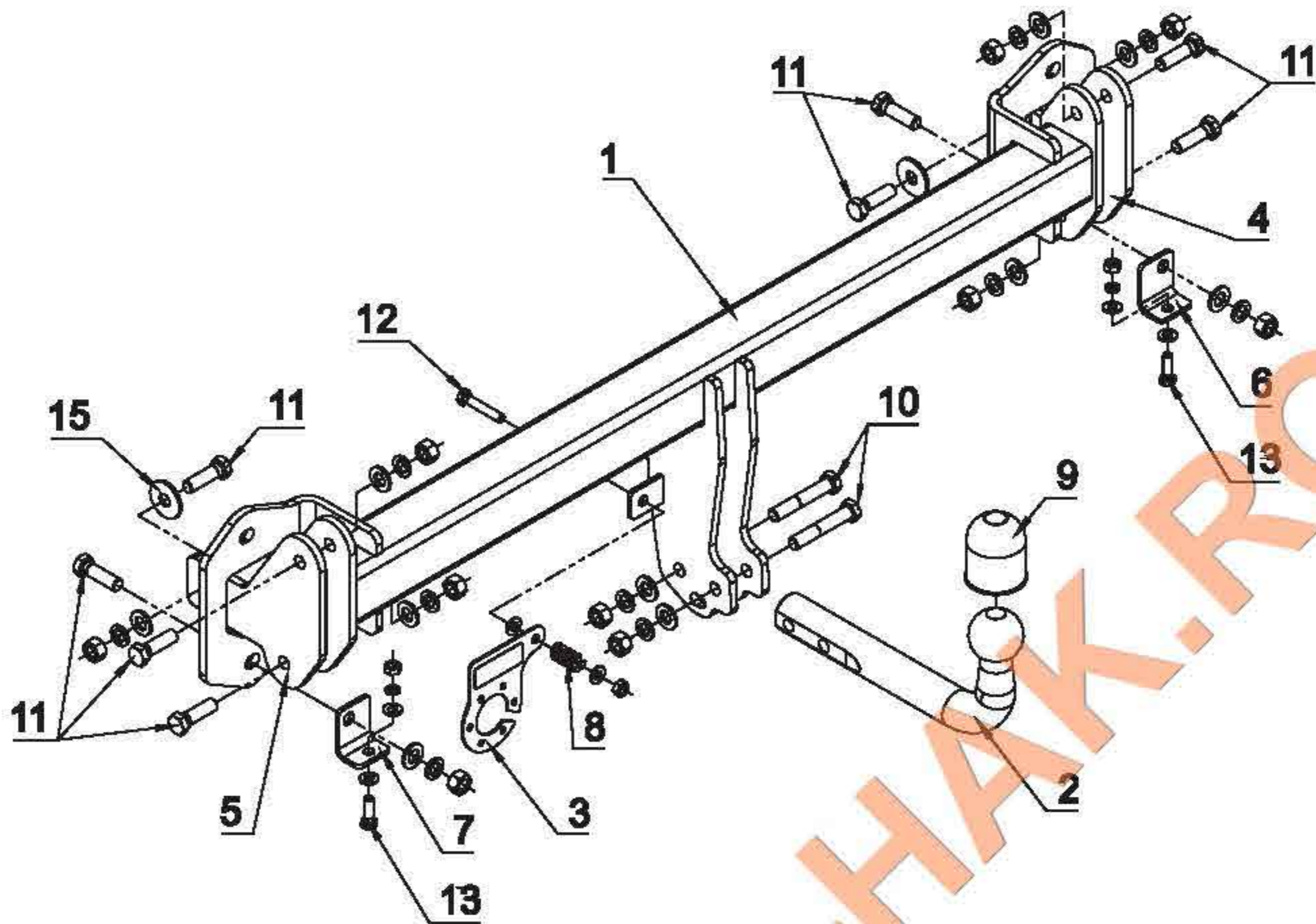

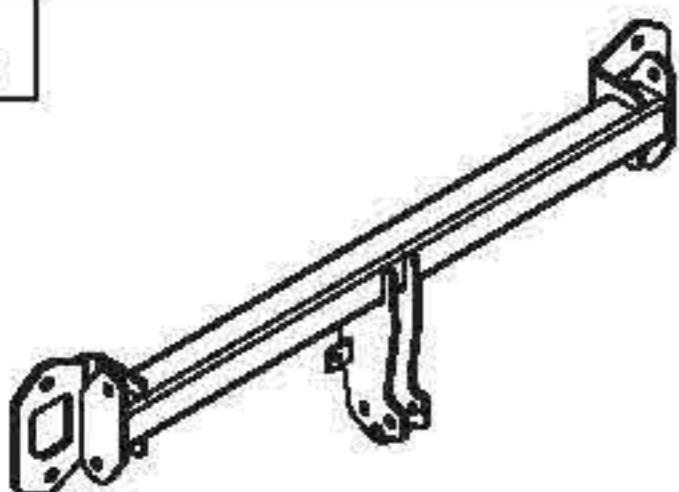



0 km →

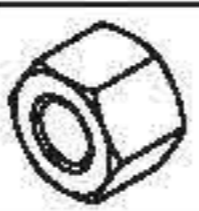

1000 km

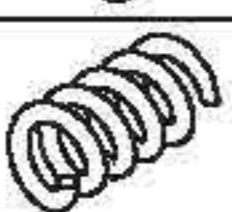

1		x1		10 M12x70	x2
				11 M12x40	x8
				12 M8x45	x1
				13 M8x25	x2
				14 ϕ 13	x10
2		x1 Art.nr-KL1D52		15 ϕ 37x ϕ 13x3 13 DIN 9021	2
3		x1 Art.nr-BL1D52		16 ϕ 8.5	x6
4		x1		17 ϕ 12.2	x10
5		x1		18 ϕ 8.2	x2
				19 M12	x10
				20 M8	x3
6		x1			
7		x1			
8		x1			
9		x1			

