

## FITTING INSTRUCTION

Clamp mark in acc. with		Cables joining
ISO	PN	
1	L	Left directional lights
2	+	Rear fog lights
3	31	Ground
4	R	Right directional lights
5	58R	Right side parking lights
6	54	Stoplights
7	58L	Left side parking lights

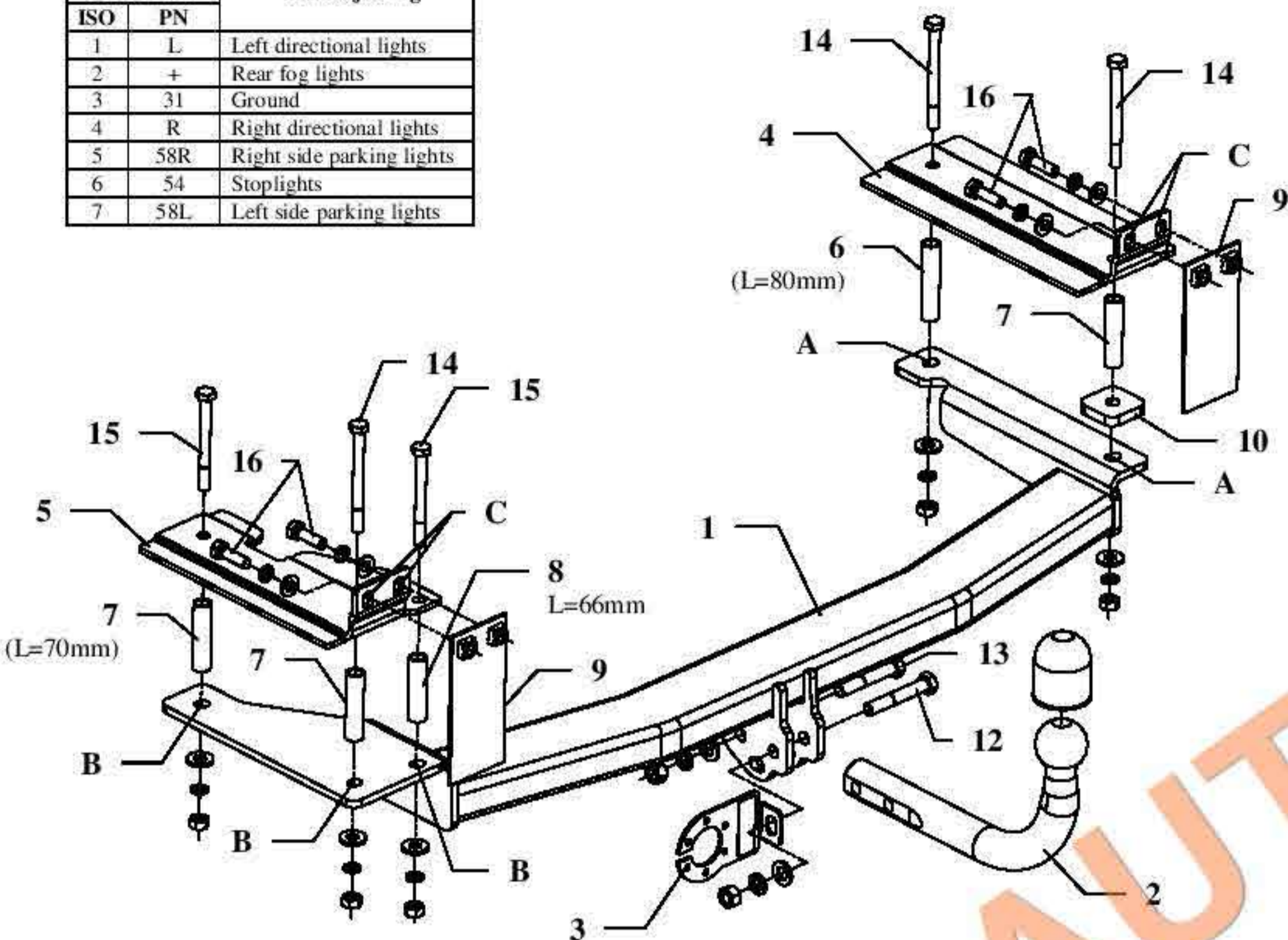

This towbar is designed to assembly in following cars:  
**OPEL VECTRA B, 4-5 door**, produced since 10.1995 till 05.2002,  
 catalogue no. **E12** and is prepared to tow trailers max total weight **1700 kg**  
 and max vertical load **75 kg**.

Torque settings for nuts and bolts (8,8):

<b>M6</b> - 11 Nm	<b>M8</b> - 25 Nm	<b>M10</b> - 50 Nm
<b>M12</b> - 87 Nm	<b>M14</b> - 138 Nm	<b>M16</b> - 210 Nm

*From manufacturer*

Thank you for buying our product. Their reliability has been confirmed in many tests. Reliability of towbar depends also on correct assembly and right operation. For this reasons we kindly ask to read carefully this instruction and apply to hints.

*The towbar should be install in points described by a car producer.*

## INSTRUCIUNI MONTAJ

1. Scoateți capacele de jos din portbagaj. La suprafețele de contact ale eclise A și B, se încălzește materialul de obturare / izolație cu un uscător și scoateți-l. De asemenea îndepărtați materialul de etanșare de pe partea de dedesubt, unde bara de remorcare atinge șasiul.
2. Se pune pește plăci pos. 4 și 5 pe podeaua portbagajului lui. Găurile A și B sunt plasate pe partea stângă și podeaua portbagajului partea dreapta a lui, peste membru șasiu stânga și dreapta. Ele sunt marcate ca urme de lovituri. Găsiți-le folosind pește plăci 4 și 5. Apoi scoate din pește plăci și de foraj podea folosind bit  $\varnothing 17\text{mm}$  trunchiului la punctele A și B.
3. Locul eclise din nou 4 și 5. Cu ajutorul ei găesc puncte C pe peretele din spate al trunchiului el. Ele sunt marcate de un producător de mașini ca și urme de lovituri.
4. Eclise și eliminați urmele de lovituri (vezi figura 2). găuri rezultante augmenta Total pozitii folosind biți  $\varnothing 12\text{mm}$ . Masina de gaurit direct prin peretele posterior al trunchiului.
5. Se pune pește plăci pos. 4 și 5 din nou, împreună cu mâneci la distanță (poz. 6, 7 și 8) și șuruburile M10x110mm (poz. 14) și M10x100mm (poz. 15), așa cum se arată pe figura. NOTĂ!! Mâneci au lungimi diferite! Platouri cu alveole pos. 9 din afara peretele din spate trunchi și repara cu ajutorul șuruburilor M10x35mm (poz. 16)
6. Se pune bara principala al barei de remorcare (poz. 1), împreună cu pătrate de spălare (poz. 10) și repara prin găurile A și B folosind cinci piulițe M10 și șaibe  $\varnothing 25 \times \varnothing 11 \times 3\text{mm}$  (pos.11).
7. Fixati cuplajul sferic (poz. 2) cu placa de soclu (poz. 3), cu ajutorul șuruburilor M12x75mm (poz. 12) și M12x70mm (poz. 13) de la accesorii.
8. Strângeți toate șuruburile conform cuplului indicat în tabel.
9. Conectați cablurile electrice de priză cu 7 poli de conform instrucțiunilor mașinii. (Recomandat pentru a face la stația de service autorizat).

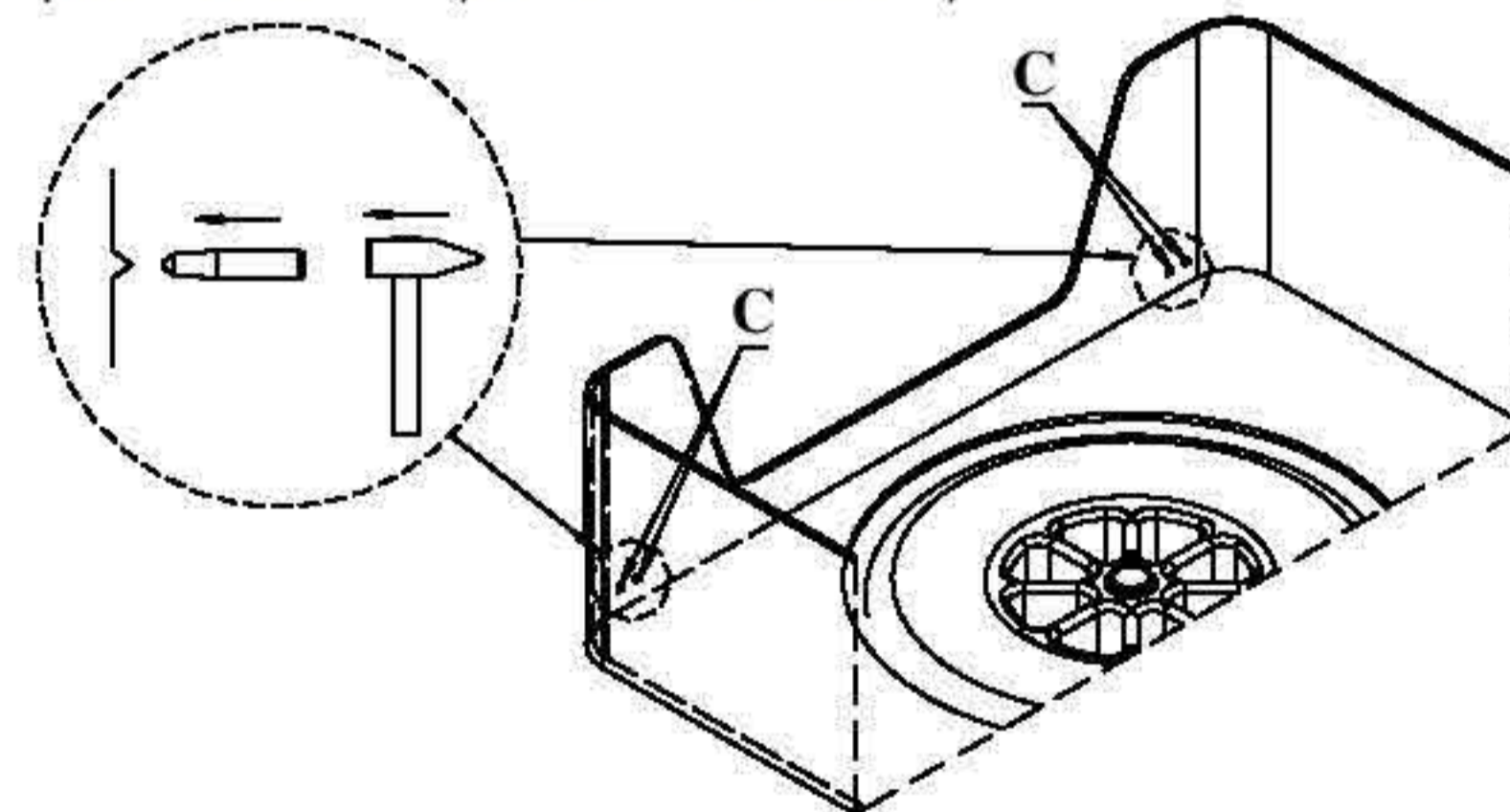

Fig. 2.

## NOTE











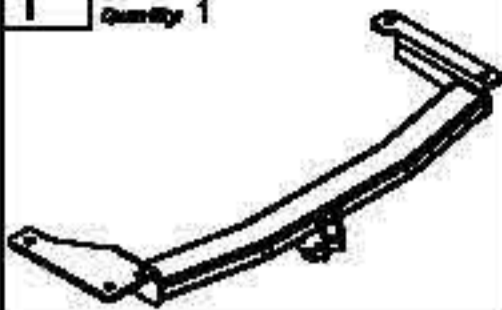

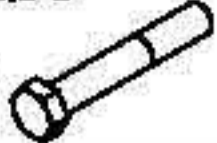



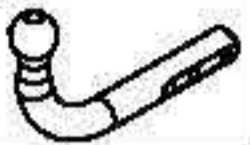

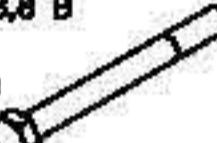
After install the towbar you should get adequate note in registration book (at authorised service station).The car should be equipped with:

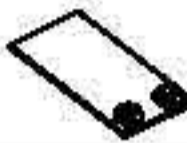
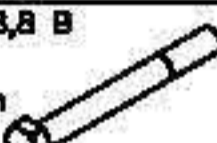
- Indicators
- Tow mirrors

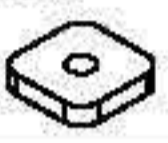
After 1000km check all bolts and nuts. The ball of towbar must be always kept clear and conserve with a grease.

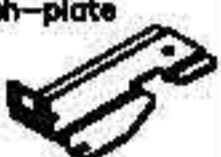

Towbar accessories:

<p>Pos. 1 Name: Main bar Quantity: 1</p> 	<p>Pos. 6 Name: Distance sleeve I Quantity: 1 Dim.: Ø17x2mm L=80mm</p> 	<p>Pos. 12 Name: Bolt 8,8 B Quantity: 1 Dim.: M12x75mm</p> 	<p>Pos. 18 Name: Nut 8 B Quantity: 5 Dim.: M10</p> 
	<p>Pos. 7 Name: Distance sleeve II Quantity: 3 Dim.: Ø17x2mm L=70mm</p> 	<p>Pos. 13 Name: Bolt 8,8 B Quantity: 1 Dim.: M12x70mm</p> 	<p>Pos. 19 Name: Podkładka zwykła Quantity: 2 Dim.: Ø 13 mm</p> 
<p>Pos. 2 Name: Tow ball Quantity: 1</p> 	<p>Pos. 8 Name: Distance sleeve III Quantity: 1 Dim.: Ø17x2mm L=66mm</p> 	<p>Pos. 14 Name: Bolt 8,8 B Quantity: 3 Dim.: M10x110mm</p> 	<p>Pos. 20 Name: Plain washer Quantity: 4 Dim.: Ø 10,5 mm</p> 
<p>Pos. 3 Name: Socket plate Quantity: 1</p> 	<p>Pos. 9 Name: Plate Quantity: 2</p> 	<p>Pos. 15 Name: Bolt 8,8 B Quantity: 2 Dim.: M10x100mm</p> 	<p>Pos. 21 Name: Spring washer Quantity: 2 Dim.: Ø 12,2 mm</p> 
<p>Pos. 4 Name: Right fish-plate Quantity: 1</p> 	<p>Pos. 10 Name: Square washer Quantity: 1</p> 	<p>Pos. 16 Name: Bolt 8,8 B Quantity: 4 Dim.: M10x35mm</p> 	<p>Pos. 22 Name: Spring washer Quantity: 9 Dim.: Ø 10,2 mm</p> 
<p>Pos. 5 Name: Left fish-plate Quantity: 1</p> 	<p>Pos. 11 Name: Washer Quantity: 5 Dim.: Ø30xØ10,5x2,5mm</p> 	<p>Pos. 17 Name: Nut 8 B Quantity: 2 Dim.: M12</p> 	<p>Pos. 23 Name: Ball cover Quantity: 1</p> 

**S.C. AUTO GEDAL IMPEX S.R.L.**

Tel: +40 745.805.990 / +40 737.122.471

Email: autogedal@gmail.com

office@auto-hak.ro

Web Page: [www.auto-hak.ro](http://www.auto-hak.ro)

**Towing hitch (without electrical set)**

Class: A50-X Cat. no. **E12**

Designed for:

Manufacturer: OPEL

Model: VECTRA B

Type: 4-5 door

produced since 10.1995 till 05.2002

Technical data:

D-value: 9,3 kN

maximum trailer weight: 1700 kg

maximum vertical cup load: 75 kg

Approval number according to Directive 94/20/EC: **e20\*94/20\*0661\*00**

*Foreword*

This towbar is designed according to rules of safety traffic regulations. The towing hitch is a safety component and can be install only by qualified personnel. Any alteration or conversion of the towing hitch is prohibited and would lead to cancellation of design certification. Remove insulating compound and underseal from vehicle (if present) in the area of the matting surfaces of the towing hitch.

The vehicle manufacturer's specifications regarding trailer load and max. vertical cup load are decisive for driving whereat values for the towing hitch cannot be exceeded.

D-value formula:

$$\frac{\text{Max trailer weight [kg]} \times \text{Max vehicle weight [kg]}}{\text{Max trailer weight [kg]} + \text{Max vehicle weight [kg]}} \times \frac{9,81}{1000} = D \text{ [kN]}$$