

S.C. AUTO GEDAL IMPEX S.R.L.

Tel: +40 745.805.990 / +40 737.122.471

Email: autogedal@gmail.com

office@auto-hak.ro

Web Page: www.auto-hak.ro

AUTO-HAK

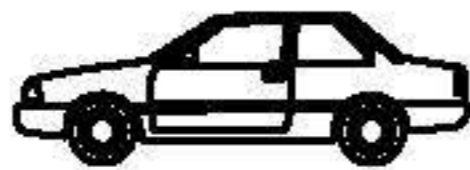

NISSAN NV 200 (M20)

Cat. no:

V70A



07.2009 →

e20

e20*94/20*1373*00

D

7,82 kN



3h



R=1250 kg

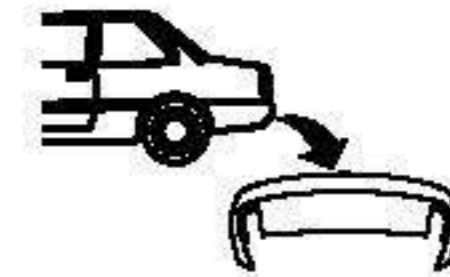

S=75 kg



18,5 kg

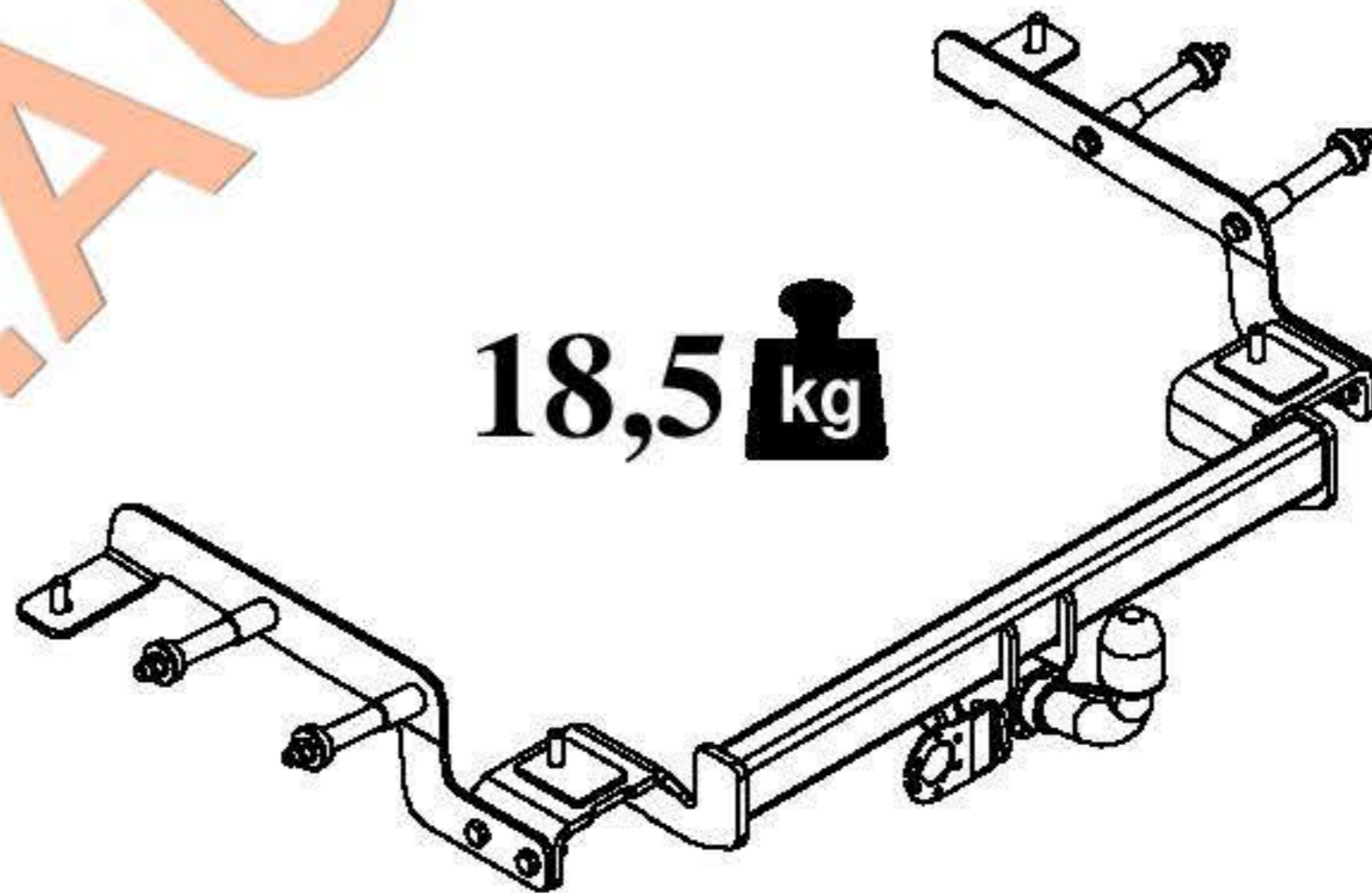

M6 - 11 Nm
M10 - 50 Nm
M14 - 138 Nm

M8 - 25 Nm
M12 - 87 Nm
M16 - 210 Nm



0 km



1000 km



El enganche de bola está construido según las normas de la seguridad de tráfico. El enganche de bola es un elemento que influye sobre la seguridad de tráfico y lo instala sólo el personal especializado. No es admisible introducir cualquier cambio en la construcción de enganche. Eso provoca expiración de permiso a la aplicación. En el caso de la presencia de masa de aislamiento o protección de chasis en el lugar de tocar de enganche, hay que quitarla. Las partes de chasis no cubiertas así como los huecos taladrados hay que pintar con pintura anticorrosiva. Las informaciones de calidad de carga comprometidas por la parte del productor de coche, de la calidad relativa de masa del remolque así como su presión máxima a la bola cuando valor de parámetros del enganche de bola puede estar superado.

Fórmula de calcular de valor de fuerza D:

$$\frac{\text{Max. Masa de coche (kg)} \times \text{Max. Masa de coche (kg)}}{\text{Max. Masa de coche (kg)} + \text{Max. Masa de coche (kg)}} \times \frac{9,81}{1000} = D \text{ [kN]}$$



De kogeltrekhaak is zo gemaakt dat deze aan de veiligheidsregels voor het wegverkeer voldoet. Een kogeltrekhaak is van invloed op de verkeersveiligheid en mag daarom alleen door gespecialiseerd personeel worden geïnstalleerd. In de constructie van de trekhaak mogen geen wijzigingen worden aangebracht, anders komt de vergunning voor het gebruik ervan te vervallen. Indien er onder het chassis sprake is van een isolerende laag en/of beschermfolie op de plaats waar de trekhaak moet worden bevestigd, dan dienen deze te worden verwijderd. Onbedekte delen van de carrosserie en geboorde gaten moeten worden bestreken met anti-corrosieverf. Voor de belastingswaarde gelden de door de fabrikant van de auto aangeleverde gegevens voor wat betreft het maximale gewicht van de aanhangwagen en de maximale druk op de kogel. De waarden van de parameters voor een kogeltrekhaak mogen niet worden overschreden.

Formule voor het berekenen van de D-waarde:

$$\frac{\text{Max. gewicht aanhangwagen [kg]} \times \text{Max. gewicht auto [kg]}}{\text{Max. gewicht aanhangwagen [kg]} + \text{Max. gewicht auto [kg]}} \times \frac{9,81}{1000} = D \text{ [kN]}$$

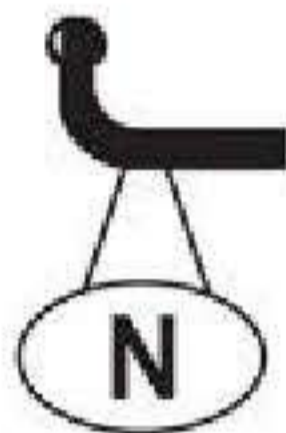

Kulefestet er konstruert i overensstemmelse med trafikkreglernes bestemmelser. Kulefestet har innflytelse på kjøresikkerheten og skal kun monteres av faglært personale. Det er forbudt å utføre endringer på kulefestet. Dette kan føre til tilbaketrekking av brukstillatelsen. I tilfelle det finnes isoleringsmasse eller understellsbeskyttelse nær kulefestet, skal disse fjernes. Ubeskyttede deler av karosseriet og borede åpninger skal males med anti-korrosjon maling. Det er opplysningene fra bilprodusenten angående de tillatte belastningene som er avgjørende. Dette er også gjeldende for den maksimale vekten av tilhengeren og den maksimale belastningen for kulan; parameterverdiene for kulefestet skal ikke overstiges.

Formel til beregning av D-verdien :

$$\frac{\text{Max vekt av tilhengeren [kg]} \times \text{Max. vekt av bilen [kg]}}{\text{Max vekt av tilhengeren [kg]} + \text{Max. vekt av bilen [kg]}} \times \frac{9,81}{1000} = D \text{ [kN]}$$



Dragkroken är konstruerad att fylla alla krav av trafiksäkerheten. Dragkroken påverkar trafiksäkerheten och därför kan endast installeras av kvalificerade specialister. Dragkrokens konstruktion får inte ändras eller modifieras på något sätt. I motsatt fall kan användningen utgöra en fara och blir olaglig. Om dragkroken ska skruvas fast till en yta med isolering på bör den tas bort före installationen. Alla punkter i karosseriet och de förborrade hål som kvarstår utan skydd mot rost ska målas med korrosionsskyddande färg. Data som blivit angiven av bil tillverkaren beträffande maximal belastning för bilen och trailer borde anses som giltig och bindande för bilanvändaren. Man ska också ta hänsyn till trailers maximala vikt och den maximala acceptabla tryckstyrkan på kulan. Samtidigt får man inte överskrida följande parametervärden för dragkroken.

D - styrkan räknas enligt en följande formel:

$$\frac{\text{Trailers maximala vikt (kg)} \times \text{Bilens maximala vikt}}{\text{Trailer egenvikt (kg)} + \text{Bilens egenvikt (kg)}} \times \frac{9,81}{1000} = D \text{ [kN]}$$



Il gancio di traino a sfera è costruito in conformità con le regole di sicurezza relative al traffico stradale. Il gancio di traino a sfera è un elemento in grado di influire sulla sicurezza di guida e può essere installato esclusivamente da personale specializzato. Non è consentito apportare modifiche alla costruzione del gancio di traino. La loro eventuale presenza comporterà il ritiro del permesso all'utilizzo su strada. In presenza di una massa isolante o di una carenatura del sottoscocca nel punto di attacco del gancio, sarà necessario rimuoverle. Le aree non protette della carrozzeria ed i fori realizzati devono essere trattati con vernice anticorrosione. Le informazioni di riferimento relative al valore dei carichi, riguardanti il peso massimo del rimorchio e la massima pressione esercitata sulla sfera, sono quelle fornite dal fabbricante dell'automobile. I valori dei parametri del gancio di traino a sfera non possono essere superati.

Formula per il calcolo del valore della forza D:

$$\frac{\text{Max Peso del rimorchio [kg]} \times \text{Max Peso dell'automobile [kg]}}{\text{Max Peso del rimorchio [kg]} + \text{Max Peso dell'automobile [kg]}} \times \frac{9,81}{1000} = D \text{ [kN]}$$

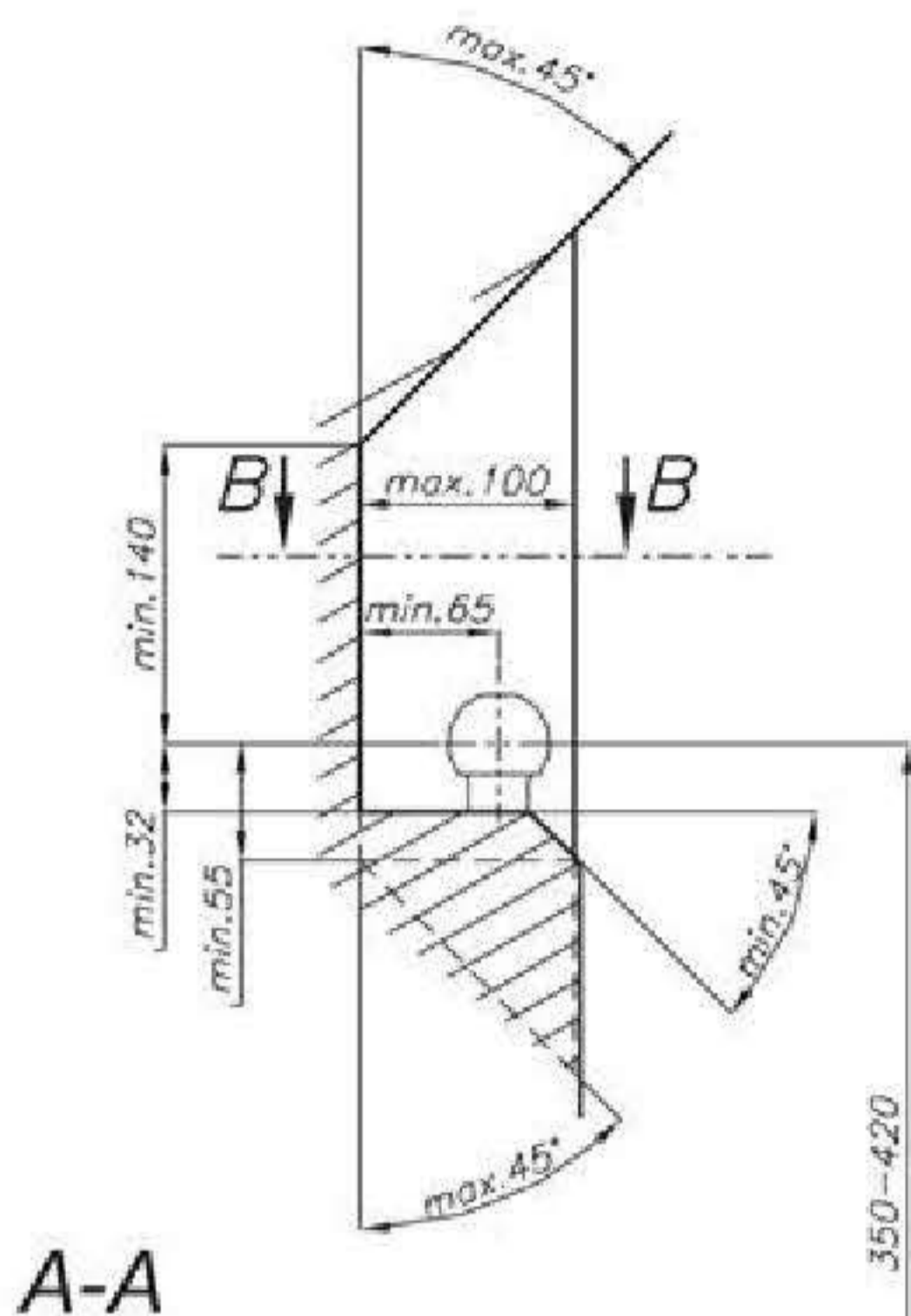

A-A

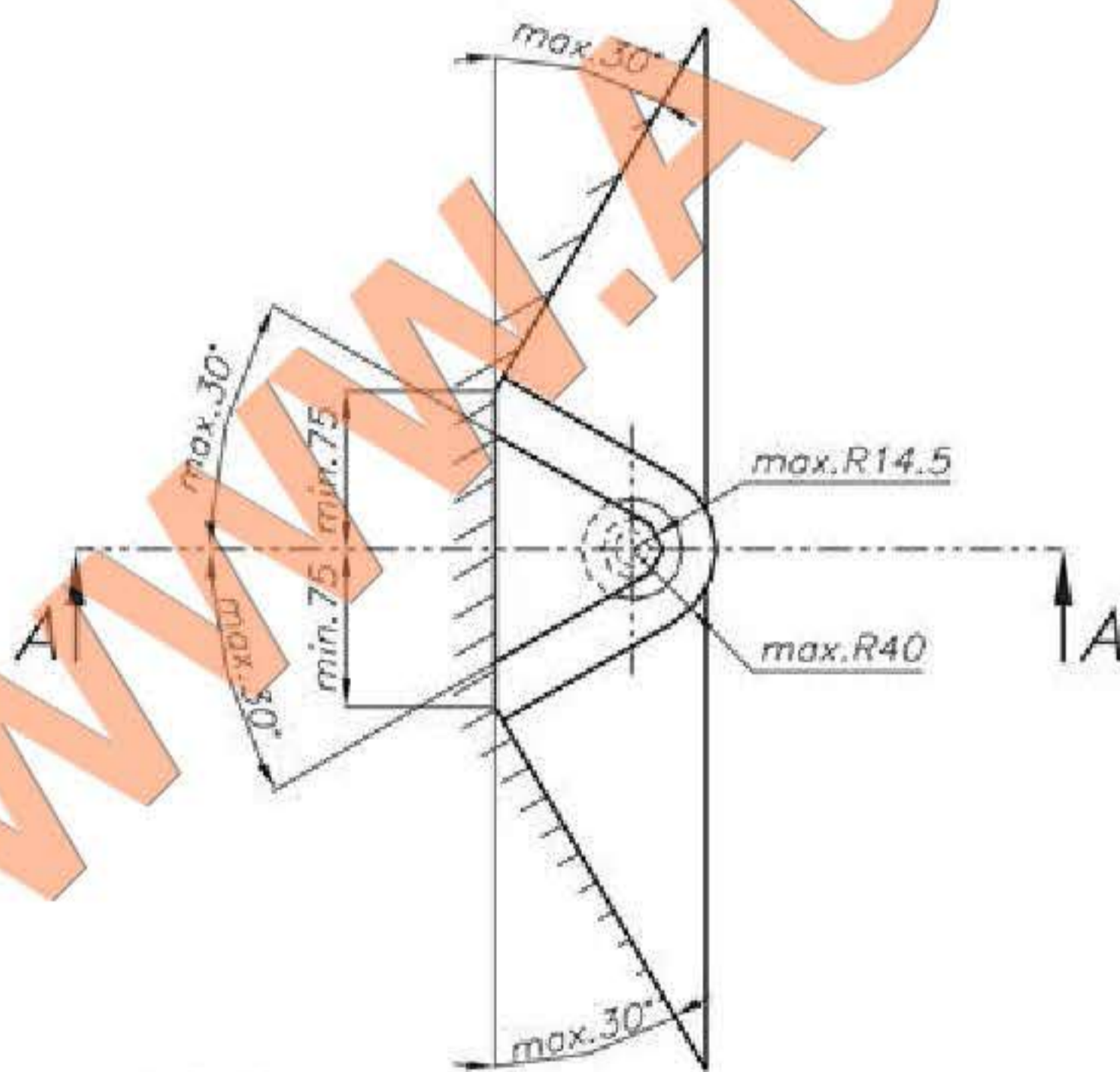

B-B



Clearance-ul specificat în apendicele VII, diagrama 25a / b din Regulamentul nr 55.01 ONU UE trebuie să fie garantată în greutate maximă a vehiculului



The clearance specified in appendix VII, diagram 25a/b of Regulation No. 55.01 UNEU must be guaranteed at laden weight of the vehicle.



Der Freiraum nach Anhang VII, Abbildung 25a/b der Vorschriften 55.01 EG ist zu gewährleisten bei zulässigem Gesamtgewicht des Fahrzeuges.



L'espace libre doit être garanti conformément à l'annexe VII, illustration 25a/b de la réglementation 55.01 CE pour un poids total en charge autorisé du véhicule.



I overensstemmelse med bilag VII, figur 25a/b til forordninger 55.01 EF for køretøjets tilladte totalvægt skal der garanteres en friplads.



Hay que garantizar un espacio suelto según archivo adjunto VII, ilustración 25a/b regulaciones 55.01 UN EU de peso admisible y total del vehículo.



De in bijlage VII afbeelding 25a/b vanreglement 55.01 UN EU gespecificeerde vrije ruimte moet bij een maximale gewichtsbelasting van het voertuig gegarandeerd zijn.



Det skal sørges for fritt rom ifølge vedlegget VII, illustrasjon 25a/b forskrifter 55.01 UN EU ved den tillatte totale vekten av fartøyet.



Man ska garantera ett fritt tillgängligt utrymme - se bilaga VII, diagram 25a/b enligt föreskrifter 55.01 vid ett fordons maximala belastning.



Occorre garantire lo spazio libero indicato all'allegato VII illustrazione 25ab/ della normativa 55.01 CE, in presenza del massimo carico ammissibile del veicolo.



DE LA PRODUCATOR:



Vă mulțumim pentru achiziționarea produsului nostru. Fiabilitatea lor a fost confirmată în mai multe teste. Fiabilitatea depinde, de asemenea, de Bara de tractare corectă asamblare și operare dreapta. Motivele pentru care acest lucru în rugăm să citiți cu atenție această instrucțiune și se aplică indicii. Carligul de remorcare trebuie să fie instalat în punctele descrise de către un producător auto.



FROM MANUFACTURER:



Thank you for buying our product. Their reliability has been confirmed in many tests. Reliability of towbar depends also on correct assembly and right operation. For this reasons we kindly ask to read carefully this instruction and apply to hints. *The towbar should be install in points described by a car producer.*



VON DEM HERSTELLER:



Die Zuverlässigkeit der Anhängerkupplung ist jedoch auch von der ordnungsgemäßen Montage und der richtigen Nutzung abhängig. Daher werden Sie gebeten, sorgfältig die folgende Montageanleitung zu lesen und sich an die entsprechenden Anweisungen zu halten.

Die Anhängerkupplung muss an den vom Fahrzeughersteller vorgeschriebenen Befestigungsstellen montiert werden.



DE LA PART DU FABRICANT:



Merci d'avoir choisi le dispositif d'attelage à boule produit par notre société. Sa fiabilité a été confirmée par de nombreux tests et a travers l'opinion des clients satisfaits. Toutefois, la fiabilité des dispositifs d'attelage à boule dépend également d'une installation et d'une utilisation correcte. Pour cette raison, nous vous demandons de lire attentivement cette instruction de montage et d'en respecter les consignes.

Le dispositif d'attelage à boule doit être monté dans des emplacements prévus à cet effet par le fabricant de voiture.



FRA PRODUCENTEN:



Tak fordi De har valgt vores anhængertræk. Dets pålidelighed er blevet bekræftet i mange undersøgelser samt af tilfredse kunder. Vores anhængertræks pålidelighed er også afhængig af korrekt montering og korrekt betjening.

Af denne grund beder vi Dem at læse denne instruktion grundigt og overholde de korrekte anvisninger.



DE PRODUCTOR:



Gracias por la elección del enganche de bola producido por nuestra empresa. Su fiabilidad fue confirmada por numerosos tests y opiniones de los clientes quienes estuvieron contentos. Sin embargo la fiabilidad de enganche de bola depende también de un montaje adecuado y su explotación adecuada.

Por esa causa por favor leer atentamente la instrucción del montaje y observar adecuadas indicadoras.



VAN DE FABRIKANT:



Bedankt voor de aanschaf van onze kogeltrekhaak. Hoe betrouwbaar die is blijkt wel uit vele tests en meningen van tevreden klanten. Toch is de betrouwbaarheid van een kogeltrekhaak er mede van afhankelijk dat deze correct gemonteerd is en op de juiste manier wordt gebruikt.

Daarom wordt u verzocht deze montagehandleiding zorgvuldig te lezen en de aanwijzingen te volgen.



FRA PRODUSENTEN:



Takk for at dere har valgt kulefestet produsert av vårt firma. Driftssikkerheten på kulefestet har blitt bekreftet av flere tester og tilbakemeldinger fra fornøyde kunder. Allikevel er driftssikkerheten også avhengig av en korrekt montering og riktig bruk.

Derfor ber vi dere om å lese denne monteringsinstruksen nøye og anbefaler at dere følger veiledningen.



ETT BUDSKAP FRÅN TILLVERKAREN:



Vi skulle vilja tacka er för ert val och inköp. Våra dragkrokars pålitlighet har bevisats av olika tester samt referenser från nöjda kunder. Man får inte glömma att dragkrokars pålitlighet beror också på rätt installation och rätt bruk. Därför skulle vi vilja be att ni läser noga denna installationsanvisning och följer alla regler och tips som den anger.

Dragkroken ska installeras i ett ställe som blivit påpekade av biltillverkaren.



DAL FABBRICANTE:



Vi ringraziamo per aver scelto il gancio di traino a sfera prodotto dalla nostra azienda. La sua affidabilità è stata confermata da numerosi test e dalle opinioni positive dei clienti. Tuttavia, il perfetto funzionamento dei ganci di traino a sfera dipende anche dalla correttezza del montaggio e dall'utilizzo appropriato. Per questo motivo, Vi preghiamo di leggere attentamente le presenti istruzioni di montaggio e di attenervi alle indicazioni in esse contenute.

Il gancio di traino deve essere montato nei punti predisposti a tal fine dal fabbricante del veicolo.



Acest lucru este proiectat în conformitate Bara de tractare cu regulile regulilor de circulație de siguranță. Cârligul de remorcare este o componentă de siguranță și, să fie instalați numai de către personal calificat. Orice modificare sau transformare a carligul de remorcare este interzisă și ar conduce la anularea certificării de proiectare. Compus și eliminarea underseal din vehicul (dacă este prezent) izolator în zona a suprafețelor matisare ale specificațiilor de remorcare a vehiculului hitch. The producătorului cu privire la sarcină a remorcii și max. încărcare verticală cupa sunt decisive pentru conducere valorile Privii pentru cârligul de remorcare nu poate fi depășită

Formula D-valoare:

$$\frac{\text{Masa maxima a remorcii [kg]} \times \text{Masa maxima a masinii [kg]}}{\text{Masa maxima a remorcii [kg]} + \text{Masa maxima a masinii [kg]}} \times \frac{9,81}{1000} = D \text{ [kN]}$$



This towbar is designed according to rules of safety traffic regulations. The towing hitch is a safety component and can be install only by qualified personnel. Any alteration or conversion of the towing hitch is prohibited and would lead to cancellation of design certification. Remove insulating compound and underseal from vehicle (if present) in the area of the matting surfaces of the towing hitch. The vehicle manufacturer's specifications regarding trailer load and max. vertical cup load are decisive for driving whereat values for the towing hitch cannot be exceeded

D-value formula:

$$\frac{\text{Max trailer weight [kg]} \times \text{Max vehicle weight [kg]}}{\text{Max trailer weight [kg]} + \text{Max vehicle weight [kg]}} \times \frac{9,81}{1000} = D \text{ [kN]}$$



Die Anhängerkupplung erfüllt die Vorschriften der Verkehrssicherheit. Sie beeinflusst die Fahrsicherheit und daher ist sie ausschließlich nur vom Fachpersonal zu montieren. Es dürfen keinesfalls Konstruktionsänderungen vorgenommen werden, sonst erlischt die Verwendungszulassung. Falls es eine Isolationsschicht oder Fahrzeugunterbodenschutz gibt, wo die Anhängerkupplung befestigt wird, so ist dieser zu entfernen. Andere Karosseriestellen und gebohrte Löcher sind mit der Antikorrosionsfarbe anzustreichen. Für die Belastungswerte gelten die vom Fahrzeughersteller angegebenen Daten bzw. max. Masse der Anhänger und max. Stützlast. Dabei dürfen die Höchstkenwerte der Anhängerkupplung nicht überschritten werden.

D-Wert Formel:

$$\frac{\text{max. Masse Anhänger [kg]} \times \text{Max. Fahrzeuggesamtgewicht [kg]}}{\text{max. Masse Anhänger [kg]} + \text{Max. Fahrzeuggesamtgewicht [kg]}} \times \frac{9,81}{1000} = D \text{ [kN]}$$



L'attelage est conçu en conformité avec les principes de sécurité de la circulation de la route. L'attelage est un facteur qui influence la sécurité routière et doit être installé uniquement par du personnel qualifié.

Toute modification de la construction de l'attelage est interdite. Cela entraîne l'annulation de l'autorisation de mise en circulation du véhicule. S'il y en a, enlever le mastic isolant ou la couche de protection du châssis, à proximité de la surface d'appui du crochet. Appliquer une couche de protection antirouille sur les parties nues de la carrosserie et sur les trous.

Les informations quant aux valeurs du poids maximal de la remorque et de la pression maximale autorisée sur la boule d'attelage sont celles fournies par le constructeur du véhicule. Ces valeurs ne peuvent pas être dépassées.

La formule pour calculer la puissance D:

$$\frac{\text{poids maximum de remorque [kg]} \times \text{poids maximum de véhicule [kg]}}{\text{poids maximum de remorque [kg]} + \text{poids maximum de véhicule [kg]}} \times \frac{9,81}{1000} = D \text{ [kN]}$$









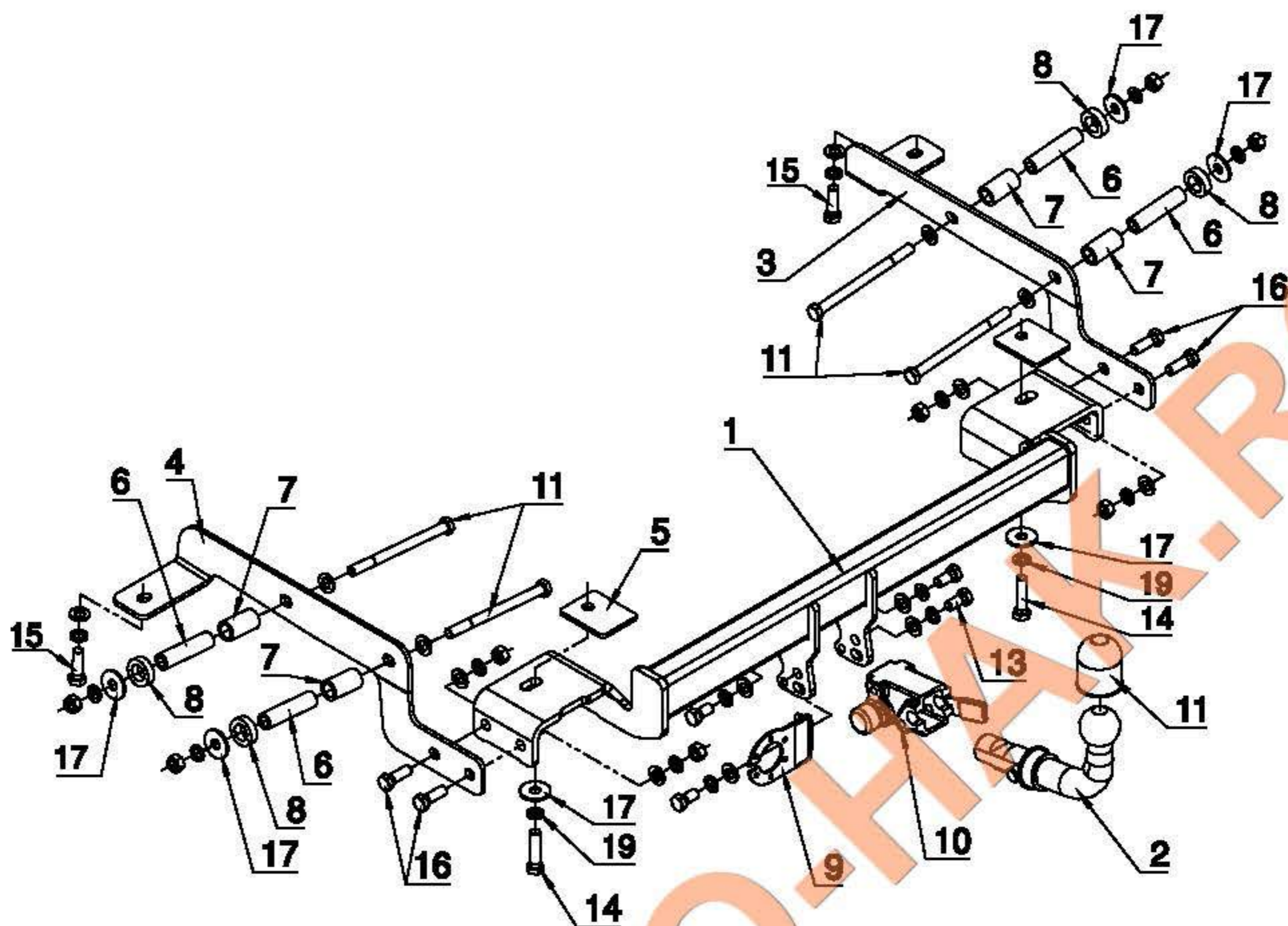

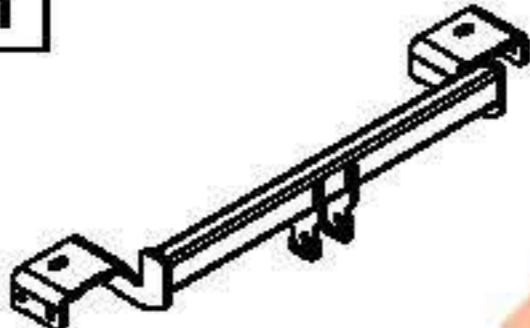



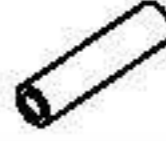

Anhængertrækket er designet i henhold til trafikikkerhedsreglerne. Anhængertrækket er et element, der påvirker køresikkerheden og kan kun installeres af kvalificeret personale. Foretages der ændringer af anhængertrækkets udførelse. Medfører dette inddragelse af brugstilladelse. Ved tilstedeværelse af formskum eller tildækning af understel ved anhængertrækkets monteringssted, skal disse fjernes. Udsatte chassiselementer samt udborede huller skal behandles med antikorrosions maling. Data anført af bilproducenten, eventuelt værdier for trailerens maksimale vægt samt maksimalt tryk på kuglen er bindende oplysninger om lastværdier, dog må parameterværdier for anhængertrækket ikke overskrides.

Formlen til beregning af kraft D:

$$\frac{\text{Maks.Trailervægt [kg]} \times \text{Maks.Bilens vægt [kg]}}{\text{Maks.Trailervægt [kg]} + \text{Maks.Bilens vægt [kg]}} \times \frac{9,81}{1000} = D \text{ [kN]}$$



1		x1		12 M12x160	x4
				13 M12x25	x4
				14 M12x1.25x50	x2
				15 M12x1.25x40	x2
				16 M12x35	x4
2		x1		17 ϕ 37x ϕ 13x3 13 (DIN 9021)	x6
3		x1		18 ϕ 13	x10
		Art.nr-KL1V70A		19 ϕ 12.2	x12
4		x1		20 M12	x8
5		x2		21	x1
		75x60x5mm			
6		x4			
		ϕ 20x4mm, L=80mm			
7		x4			
		ϕ 25x4mm, L=45mm			
8		x4			
		ϕ 35x ϕ 21x10mm			
9		x1			
10		x1			
		Art.nr-BL1V70A			
11		x1			

