

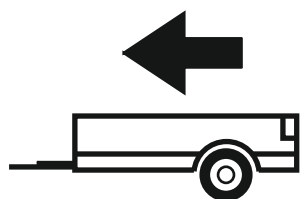

Cat. No. P/044

PEUGEOT 3008 II (excl. Hybrid)	05/16-
OPEL Grandland X (excl. Hybrid, CNG, LPG)	06/17-
CITROEN C5 Aircross (excl. Hybrid)	11/18-

**E20** E20\*55R01/06\*005670\*00



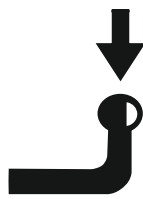

2000kg



100kg

**D** = 10,10kN

$$D \text{ (kN)} = \frac{\text{MAX kg} \times \text{MAX kg}}{\text{MAX kg} + \text{MAX kg}} \times 0,00981$$

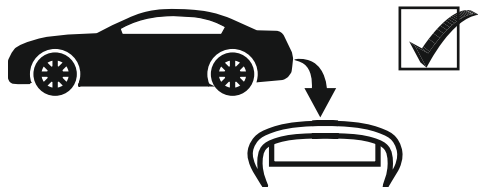



IMIOLA HAK-POL

96-111 KOWIESY, CHOJNATA 23A, POLAND

Tel. + 48 46 831 73 31, fax +48 831 74 29

e-mail: office@imiola.pl, www.imiola.pl

## PRZEKRÓJ A-A

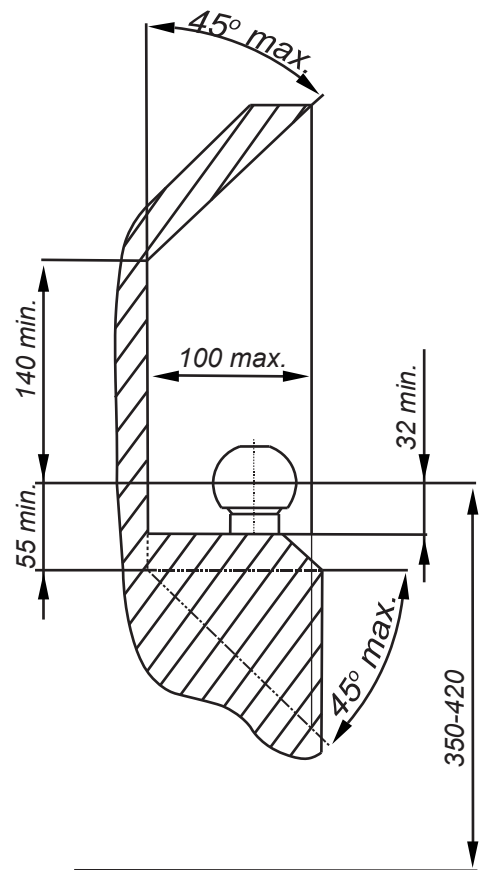
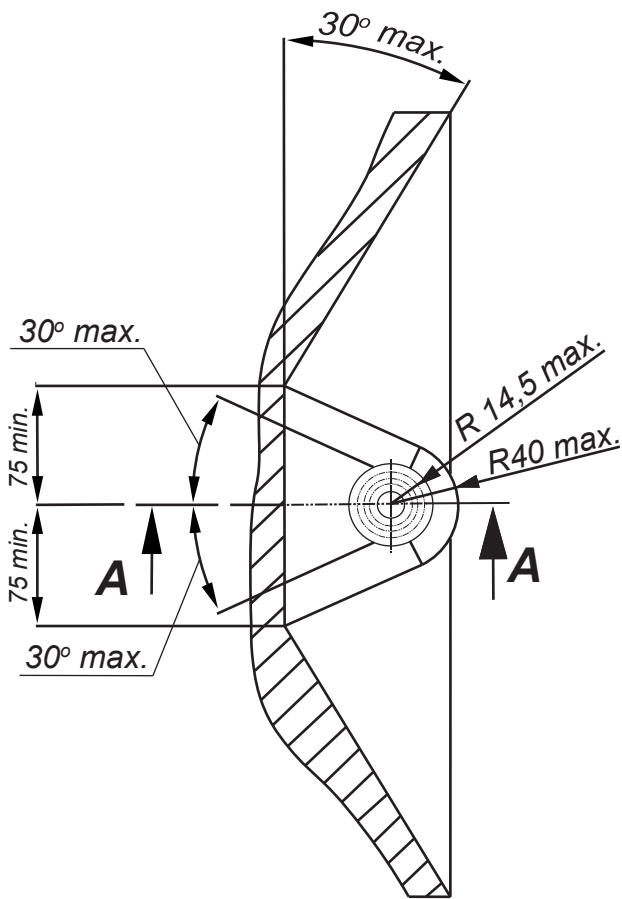

**PL** Należy zagwarantować przestrzeń swobodną według załącznika VII, rysunek 25a/b Regulaminu EKG ONZ 55.01 przy dopuszczalnym ciężarze całkowitym pojazdu.

**GB** The clearance specified in appendix VII, diagram 25a/b of Regulation No. 55.01 UN EU must be guaranteed at laden weight of the vehicle.







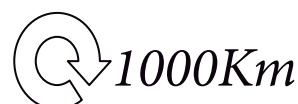

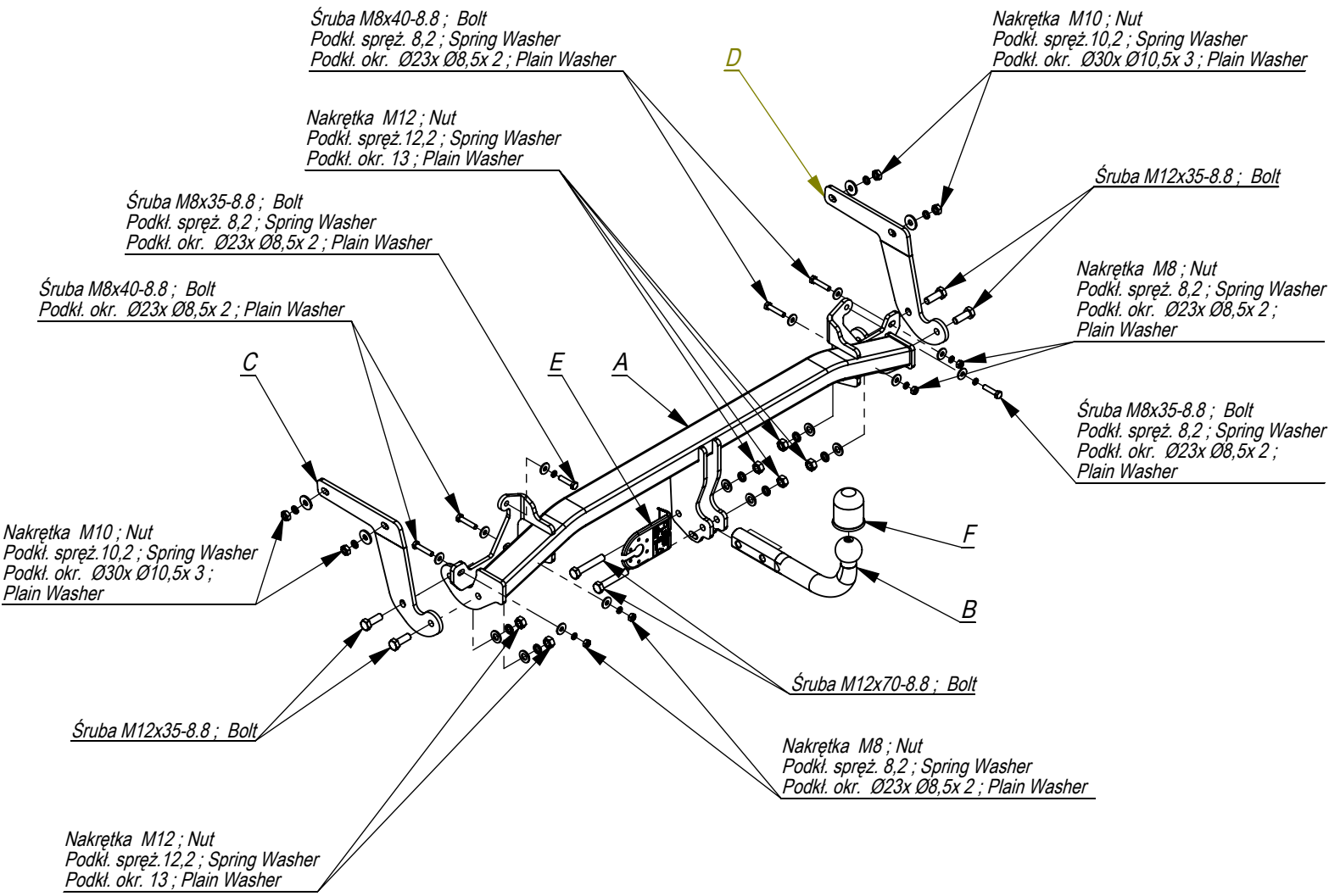

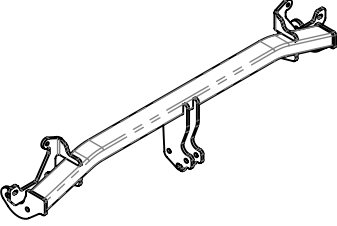
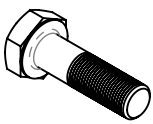
**F** L'espace libre doit être garanti conformément à l'annexe VII, illustration de la réglementation 55.01 CE pour un poids total en charge autorisé du véhicule.

**D** Der Freiraum nach Anhang VII, Abbildung 25a/b der Vorschriften 55.01 EG ist zu gew 25a/b abzuwehren bei zulässigem Gesamtgewicht des Fahrzeuges.

Moment skręcący dla śrub i nakrętek (8.8) Torque settings for nuts and bolts (8.8)	
M8	25Nm
M10	55Nm
M12	85Nm
M14	135Nm
M16	195Nm





	A	x1		M12x70	2
				M12x35	4
				M8x35	2
				M8x40	4
	B	x1		M12	6
				M10	4
				M8	4
	C	x1		Ø30xØ10,5x3	4
				Ø23xØ8,5x2	10
	D	x1		13	6
	E	x1		12,2	6
	F	x1		10,2	4
				8,2	6

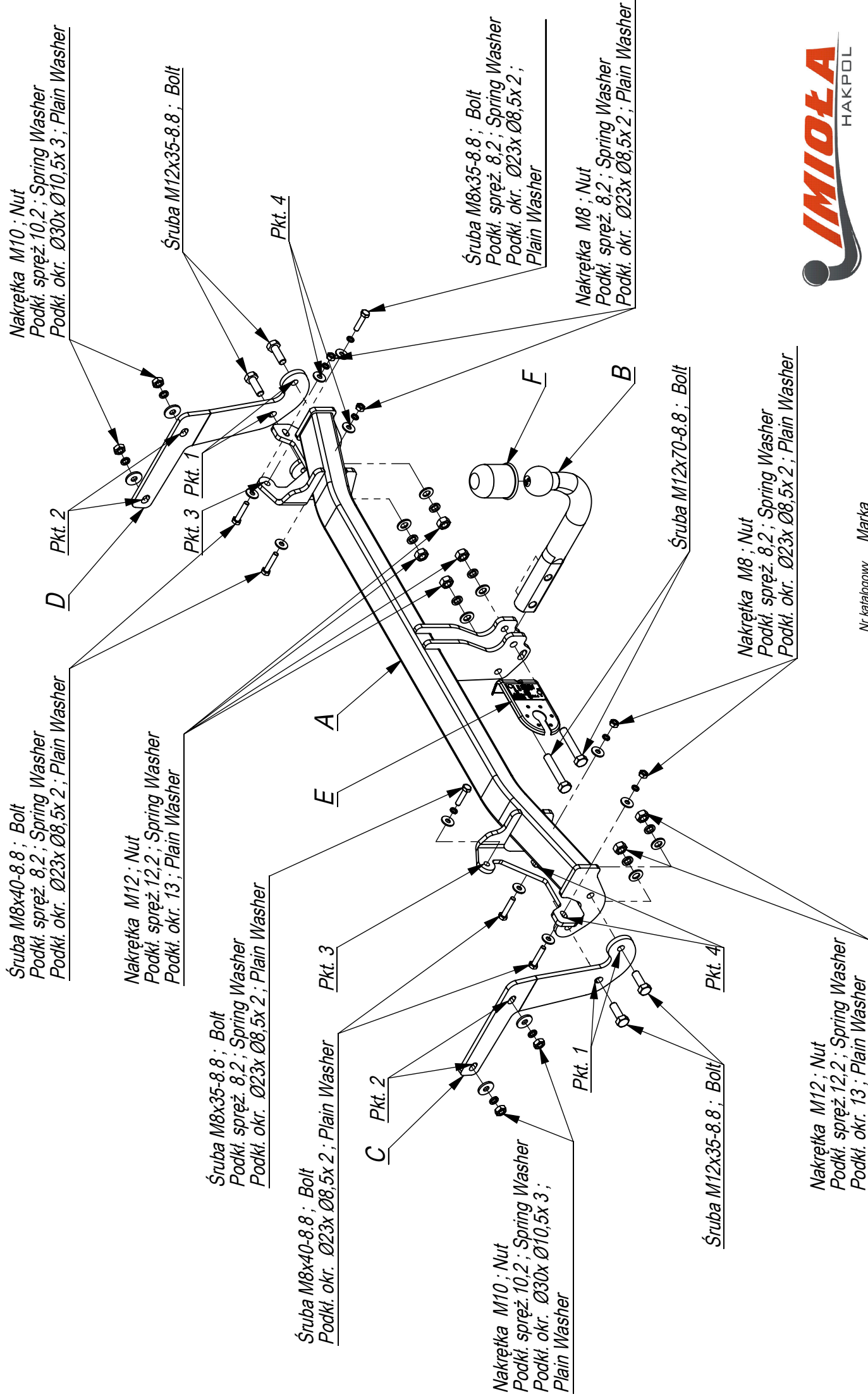

- Odkręcić zderzak i lampy.
- Odkręcić 3 śruby mocujące tylną belkę (pkt 3 i 4).
- Udrożnić otwory w podłużnicach.
- Przykręcić do tylnego pasa belkę haka A śrubami M8x40 (pkt 3 i 4).
- Elementy C i D przykręcić do podłużnic nakrętkami M10 (pkt 2) oraz do belki haka A śrubami M12x35 8.8 (pkt 1).
- Dokręcić wszystkie śruby z momentem wg tabeli.
- Przykręcić zderzak i lampy.
- Przykręcić kulę i blachę gniazda elektrycznego śrubami M12x70.
- Podłączyć instalację elektryczną.

- Unscrew the bumper and lamps.
- Unscrew three rear bar fitting bolts (point 3 and 4).
- Clear out the technological holes in the frame side members.
- Screw the main bar A to the rear belt with bolts M8x40 8.8 (point 3 and 4).
- Screw the elements C and D to the frame side members with nuts M10 (point 2) and to the main bar A with bolts M12x35 8.8 (point 1).
- Tighten all the bolts according to the torque setting- see the table.
- Screw the bumper and lamps.
- Fix the ball and electric plate with bolts M12x70.
- Connect the electric wires

- Dévisser le pare-chocs et les lampes.
- Desserrez les 3 boulons fixant la poutre arriere (point 3 et 4).
- Déboucher les trous dans les longerons.
- Visser la barre d'attelage A a la jupe arriere, avec les les boulons M8x40 8.8 point 3 et 4).
- Fixer les éléments C et D aux longerons avec les écrous M10 (point 2) et a la poutre A du crochet avec les boulons M12x35 8.8 (point 1).
- Serrer tous les boulons avec un couple de serrage selon tableau.
- Vissez le pare-chocs et les lampes.
- Visser la boule et la tôle de la prise électrique avec les boulons M12x70.
- Brancher l'installation électrique.

- Die Rückleuchten und den Stoßfänger abschrauben.
- Drei Befestigungsschrauben des hinteren Trägers abschrauben (Punkt 3 und 4).
- Die Öffnungen in den Längsträger freimachen.
- Den AHK-Querträger A mit Schrauben M8x40 (3 und 4) am hinteren Träger verschrauben.
- Die Bauteile C und D mit M10-Muttern an die Längsträger (Punkt 2) und an den AHK-Querträger A Schrauben M12x35 8.8 verschrauben..
- Ziehen Sie alle Schrauben mit dem Drehmoment gemäß der Tabelle an.
- Die Stoßstange und Rückleuchten anschrauben.
- Schrauben Sie die Kugel und den Steckdosenblech mit den Schrauben M12x70 an.
- Die Elektroinstallation anschließen.

- Desenrosque el parachoques y las lámparas.
- Desenrosque los 3 tornillos de fijación de la barra trasera (punto 3 y 4).
- Limpiar los orificios en los largueros.
- Fijar la barra del gancho a la correa trasera con tornillos M8x40 (punto 3 y 4).
- Fijar los elementos C y D a los largueros con tuercas M10 (punto 2) y a la barra del gancho A con tornillos M12x35 8.8 (punto 1).
- Apretar todos los tornillos con el par según la tabla anterior.
- Fijar el parachoques y las lámparas.
- Atornille la bola y la placa de toma de corriente eléctrica. con tornillos M12x70.
- Conectar la instalación eléctrica.

